

## VHF

### Marine VHF Radiotelephone



ACKNOWLEDGED  
ALL SHIPS MSG  
PRIORITY: SAFETY  
COMM: CH 16/TELEPHONE  
FROM: 123456789  
COMM OPTION: NO INFO  
EOS: NO ACKNOWLEDGED

ELAPSED TIME: 00H00M00S

HOLD QUIT PRINT RESEN

MMSI: 123456789

DISTRESS

CH STATUS: #16  
POWER: HIGH  
REGION: INT'L  
TYPE: SIMP

CH: LAT: 12° 34.5678' N EPFS DATA: 12:34 (UTC)  
LON: 123° 45.6789' E

TAB: RT

16

HIGH LOW  
REGION: INT'L  
TYPE: SIMP

CH: LAT: 12° 34.5678' N EPFS DATA: 12:34 (UTC)  
LON: 123° 45.6789' E

TAB: RT

# VHF

Marine VHF Radiotelephone



Model: FM-8900S

- ▶ **Semi-duplex 25-Watt VHF radiotelephone with a built-in Class-A DSC and CH70 watch Receiver**
- ▶ **Fully meets GMDSS carriage requirements for SOLAS ships**
- ▶ **Meets the new ITU recommendation on digital selective calling system for use in the Maritime Mobile Service, ITU-R M.493-13**
- ▶ **Easy to read, high-contrast 4.3" bright color LCD**
- ▶ **Enhanced noise reduction and speaker for superb voice quality**
- ▶ **Quick access to CH16 key**  
Press the CH16 key on the keypad to switch to radiotelephone display and select CH16 instantly
- ▶ **Easy channel selection with rotary control or direct keypad input**
- ▶ **Automatic entry of own ship position and time through the interfaced GPS receiver**
- ▶ **ATIS signal transmission available for inland waterways**
- ▶ **Connect to an office or home via an existing PSTN (Public Switched Telephone Network)**



# Full GMDSS-compliant VHF radiotelephone with Class-A DSC facility and CH70 watch receiver

## Scans all channels in the selected region and CH16

The FM-8900S scans all channels in the selected region as well as watches CH16 in alternate shift.

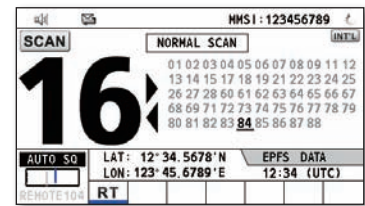

SCAN Display

## Transmitting and receiving general/distress DSC messages

By long-pressing (3 seconds) the {DISTRESS} button, DSC distress alert can be transmitted. Also, quick entry to DSC message composition screen is available by use of {DISTRESS MSG} and {OTHER DSC MSG} buttons.

For general DSC messages, press {OTHER DSC MSG} to enter the composition screen.

For DSC messages for distress alert, press {DISTRESS MSG} to enter the composition screen.

For DSC messages for DROBOSE (DSC Relay On Behalf Of Someone else), press both {DISTRESS MSG} and {OTHER DSC MSG} to enter the composition screen.

In the DSC Display, the operators can view the message log of the sent/received DSC messages.



DSC Display

## Quick access to dedicated functions in the menu operation using numeric keypad

In the menu, all tasks are assigned numbers, and the operator can access each of the menu items either by turning and pressing PUSH TO ENTER knob or simply pressing the corresponding numbers on the numeric keypad.

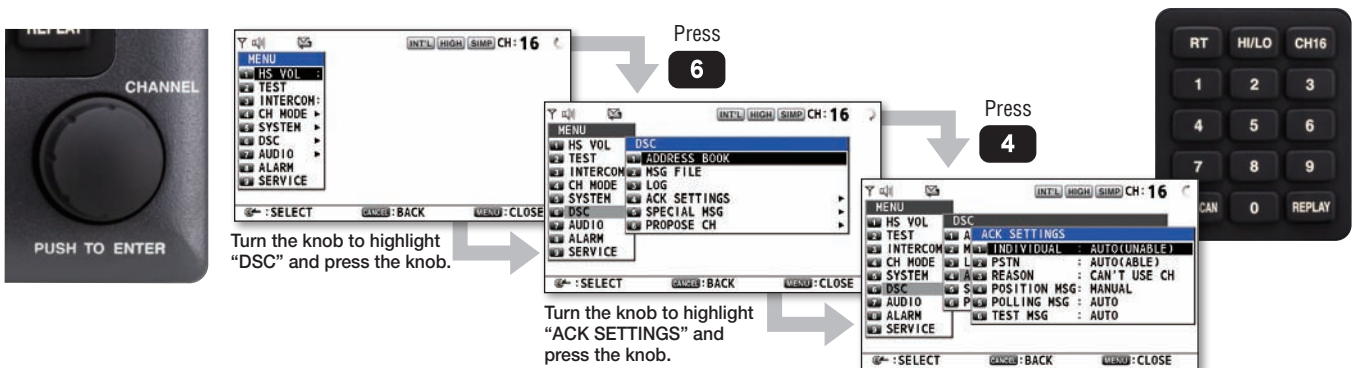

## Replay function

The FM-8900S records the latest 120 seconds of incoming communication on the currently set channel. By simply pressing the "REPLAY" button on the numeric keypad, the last-received message will be played back on the spot.

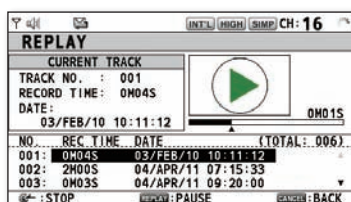

Replay Display

## Day mode and Night mode can be selected according to the lighting condition of the wheelhouse

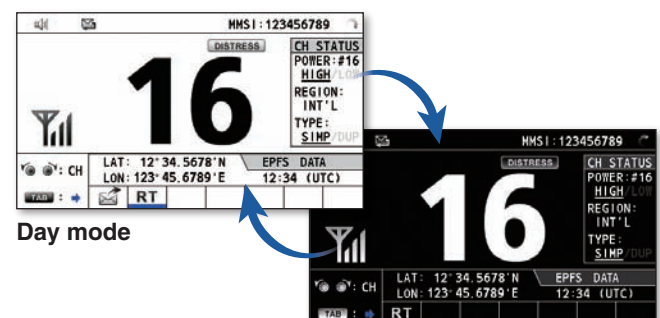

Night mode

# SPECIFICATIONS

**PRODUCT NAME** VHF RADIOTELEPHONE

## GENERAL CHARACTERISTICS

Rules and Regulations	
VHF Radiotelephone	EN 301 925 V1.3.1 (2010-09)
VHF ATIS	EN 300 698-1 V1.4.1 (2009-12)
DSC	ITU-R M.493-13 (10/2009)
	ITU-R M.541-9 (05/04)
	ITU-R M.689-2 (09/94)
	EN 300 338-1 V1.3.1 (2010-02)
	EN 300 338-2 V1.3.1 (2010-02)
Class of emission	G3E (Radiotelephone), G2B (DSC)
Communication system	Simplex/Semi-duplex
Channels	INTL: 57 (ITU-R Radio Regulations Appendix S18)
	USA: 50 (FCC 47 CFR Ch. 1 § 80.371, § 80.373)
	Canada: 57 (Industry CANADA RBR-2)
	Weather: 10 (USA and Canada, receive only)
	Inland waterway: 57 (ETSI EN 300 698-1 V1.4.1 2009-12)
	Private: 20 (permitted by administrations)
Display	MEMORY CH: 50
	4.3 inches WQVGA (480x272 dots), color dot matrix LCD

## TRANSMITTER

Frequency range	155.000 - 161.475 MHz
RF output power	High: Max 25 W, Low: Not exceed 1 W
	US version: Manual override for 25 W available on CH13, CH67 and CH77 (usually not exceed 1W)
Frequency stability	Less than ±1.5 kHz
TX timeout	Deactivates the transmitter after an uninterrupted transmission of more than 5 minutes
(for US & Inland-waterway)	An ATIS signal is transmitted at the end of transmission, by modulating the carrier at 1,300 and 2,100 Hz
ATIS	

## RECEIVER

Frequency range	Simplex: 155.000 - 159.600 MHz
	Semi-duplex: 161.475 - 164.200 MHz
Receiving system	Double-conversion super-heterodyne
	1st IF: 51.1375 MHz
	2nd IF: 62.5 kHz
Sensitivity	Less than 6 dB μV at SINAD 20 dB
Adjacent channel selectivity	70 dB or more
AF output power	Built-in speaker: 3 W (4 ohms. THD 10 % or less)
	Handset earphone receiver: 2 mW (150 ohms)
Audio response	De-emphasis of 6 dB/oct +1/-3 dB

## INTERCONNECTION DIAGRAM

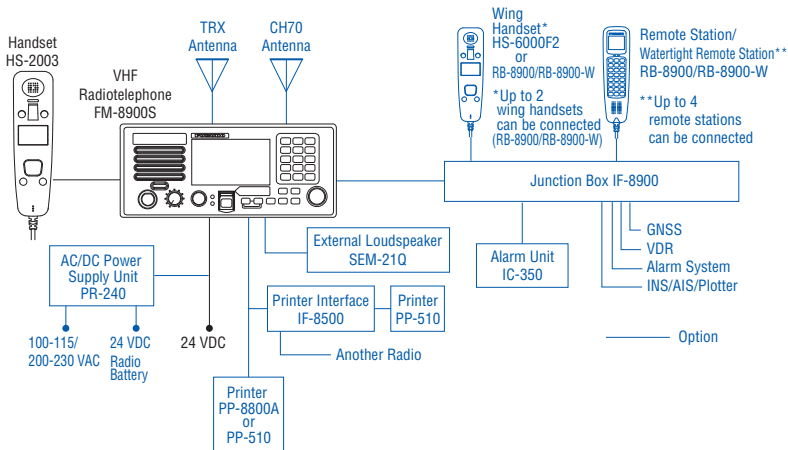

## DSC SECTION

Message log	Receive: 50 distress messages and 50 non-distress messages	
	Transmit: 50 messages	
Interface	Nav data: IEC61162-1 Ed.4	
	Printer: Centronics-compatible	
Alarm	Audible and visual on receipt of a DSC call	
DSC watch-keeping receiver	Receiving frequency	156.525 MHz (CH70)
	Sensitivity	Symbol error rate: Less than 1 % (at 0 dB μV)

## POWER SUPPLY

24 VDC, Standby: 0.6 A max., RX: 1.8 A max., TX: 4.7 A max.

## ENVIRONMENT

Temperature	-15°C to +55°C
Relative humidity	93% (at 40°C)
Waterproofing	
FM-8900S (VHF Radiotelephone)	IP20 (IP22 with option)
HS-2003 (Handset)	IP24
IF-8900 (Junction box)	IP22 (Bulkhead), IP20 (Tabletop)
RB-8900 (Remote station)	IP22
RB-8900-W (Watertight remote station)	IP56
RC-8900 (VHF console)	IP20

## EQUIPMENT LIST

### Standard

VHF Radiotelephone	FM-8900S	1 unit
Handset	HS-2003	1 unit
Handset Cradle	FP05-05510	1 unit
Installation materials and spare parts		1 set

### Option

Junction Box	IF-8900
Remote Station	RB-8900
Watertight Remote Station	RB-8900-W
Handset and Cradle	
Flush Mount Kit	OP05-129
External Loudspeaker	SEM-21Q
Printer	PP-8800A/PP-510
Printer Interface	IF-8500
AC/DC Power Supply Unit	PR-240
VHF Console	RC-8900

## Transceiver Unit (Flushmount)

### FM-8900S

4.2 kg 9.3 lb

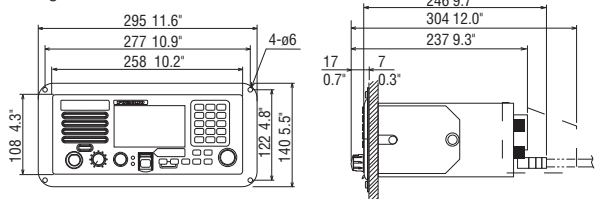

### Remote Station

#### RB-8900

0.7 kg 1.5 lb

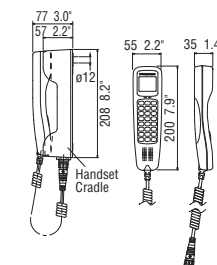

### Handset

#### HS-2003

0.2 kg 0.4 lb

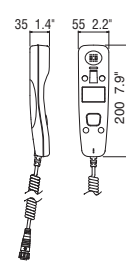

All brand and product names are registered trademarks, trademarks or service marks of their respective holders.

SPECIFICATIONS SUBJECT TO CHANGE WITHOUT NOTICE

**FURUNO ELECTRIC CO., LTD.**  
Nishinomiya, Hyogo, Japan  
www.furuno.com

**FURUNO U.S.A. INC.**  
Camas, Washington, U.S.A.  
www.furunousa.com

**FURUNO (UK) LIMITED**  
Havant, Hampshire, U.K.  
www.furuno.co.uk

**FURUNO FRANCE S.A.S.**  
Bordeaux-Mérignac, France  
www.furuno.fr

**FURUNO ESPAÑA S.A.**  
Madrid, Spain  
www.furuno.es

**FURUNO DANMARK A/S**  
Hvidovre, Denmark  
www.furuno.dk

**FURUNO NORGE A/S**  
Ålesund, Norway  
www.furuno.no

**FURUNO SVERIGE AB**  
Västra Frölunda, Sweden  
www.furuno.se

**FURUNO FINLAND OY**  
Espoo, Finland  
www.furuno.fi

**FURUNO POLSKA Sp. z o.o.**  
Gdynia, Poland  
www.furuno.pl

**FURUNO EURUS LLC**  
St. Petersburg, Russian Federation  
www.furuno.com.ru

**FURUNO DEUTSCHLAND GmbH**  
Rellingen, Germany  
www.furuno.de

**FURUNO HELLAS S.A.**  
Piraeus, Greece  
www.furuno.gr

**RICO (PTE) LTD**  
Singapore  
www.rico.com.sg

12023SK Printed in Japan  
Catalogue No. V-035